

Montering af sengeben til elevations seng

1

Åben pakken og hav en nøgle til at efterspænde med



4 stk



1 stk



4 stk



4 stk



1 stk

2

Sæt filtdupperne på de 4 sengeben for at beskytte gulvet

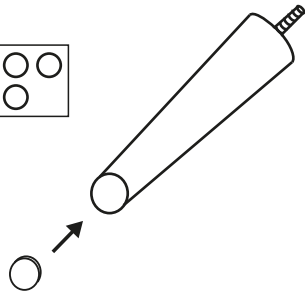

3

Vend rammen på siden

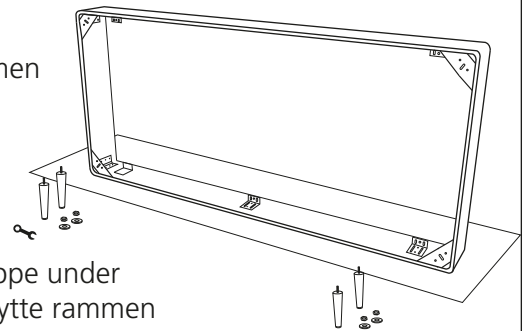

Tip:
Læg et tæppe under for at beskytte rammen

4

Sæt sengebenet i det midterste hul i beslaget

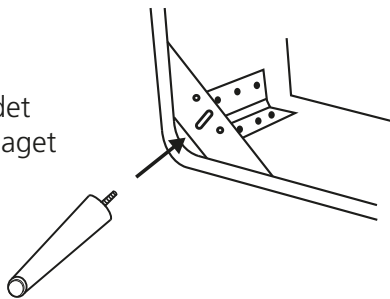

5

Placer spændeskiven på modsatte side

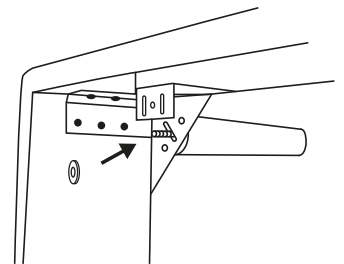

6

Skru derefter møtrikken på sengebenet

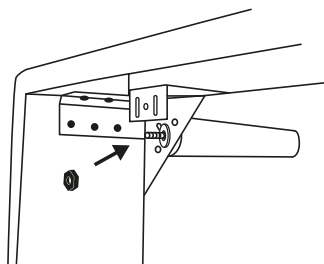

7

Efterspænd møtrikken

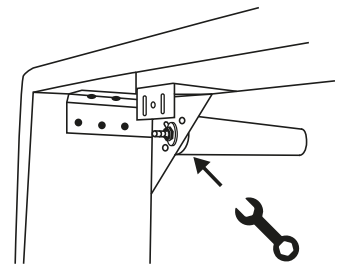

8

Gentag step 4-7 med de sidste sengeben

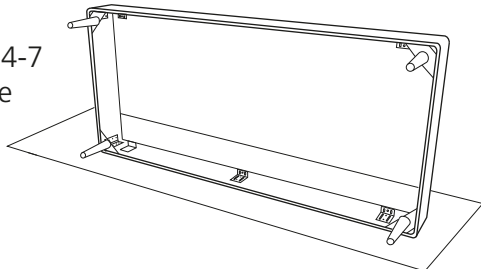

9

OBS: Vær to personer til at vende sengen for at beskytte gulvet og sengebenene

